

Place Value Blocks - 2 Digits

L2S5

Write the number formed by base ten blocks.

1)

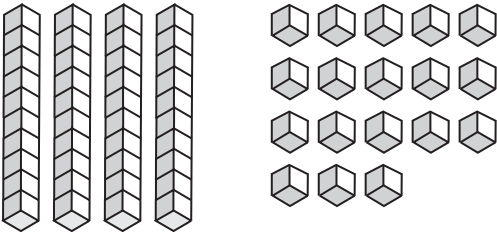

2)

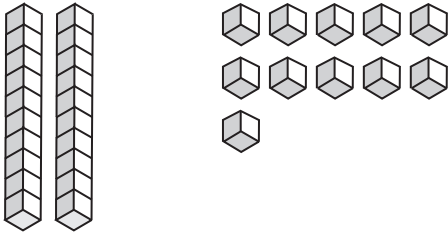

3)

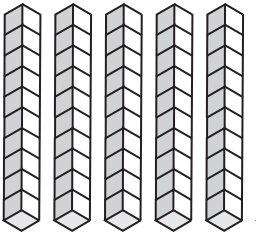
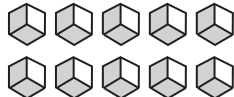
5)

PREVIEW

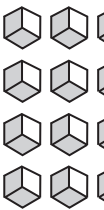
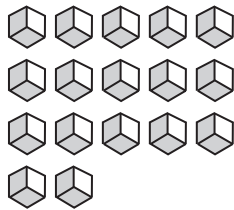
Gain complete access to the largest collection of worksheets in all subjects!

Members, please log in to download this worksheet.

Not a member? Please sign up to gain complete access.

www.mathworksheets4kids.com

7)

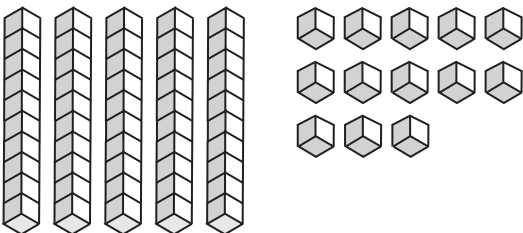

8)

