

Name : \_\_\_\_\_

## Composing & Matching

Match each set of 3D shapes to the new shape that can be constructed using them.

1)

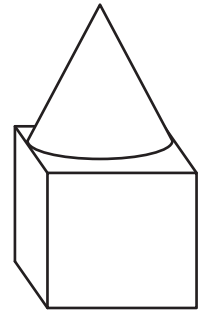
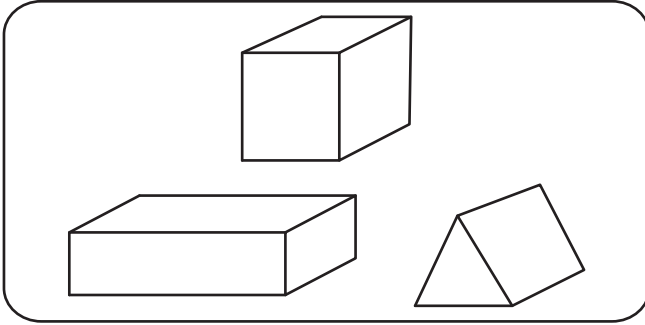

2)

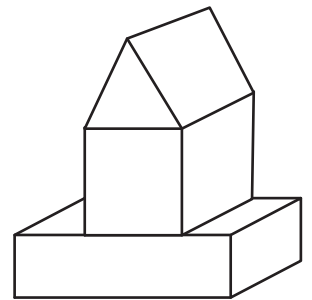
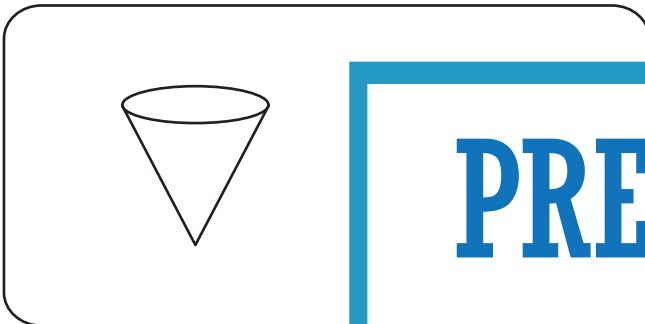

3)

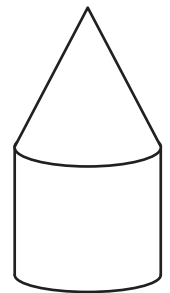
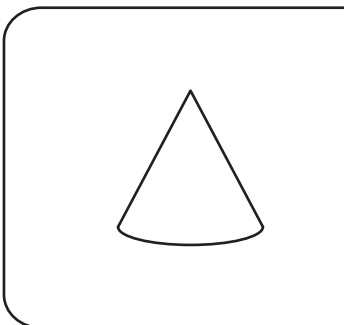

4)

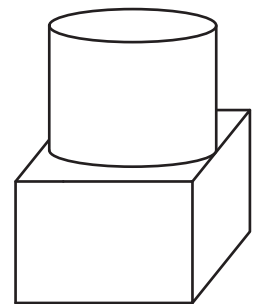
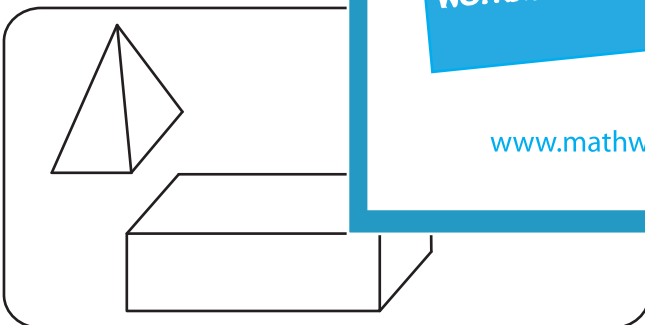

5)

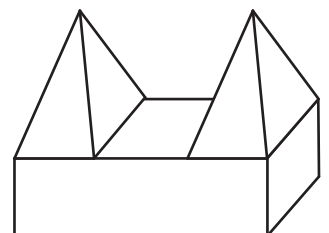
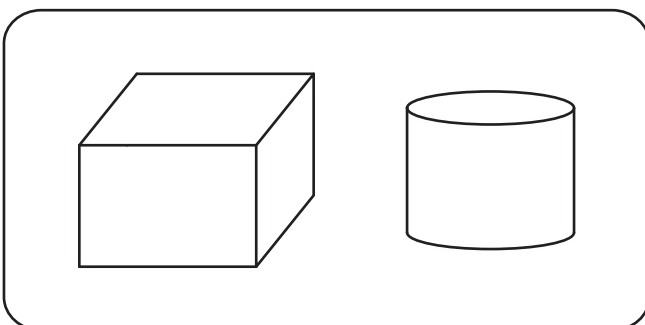

**PREVIEW**

Gain complete access to the largest collection of worksheets in all subjects!

Members, please log in to download this worksheet.

Not a member? Please sign up to gain complete access.

[www.mathworksheets4kids.com](http://www.mathworksheets4kids.com)