

# Mirror Images

Graph the image of the given figure across the mirror line.

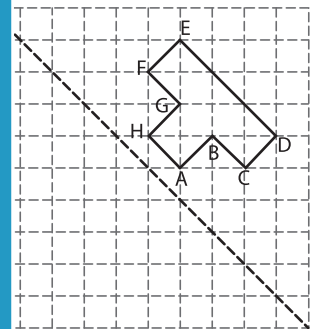
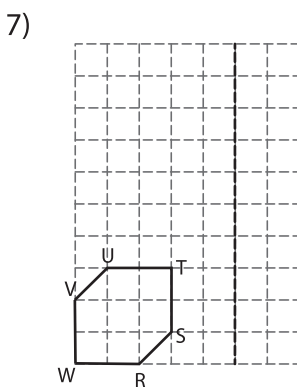
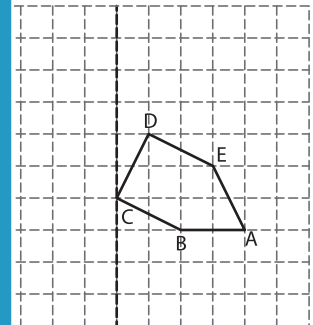
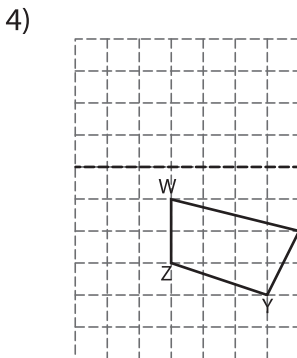
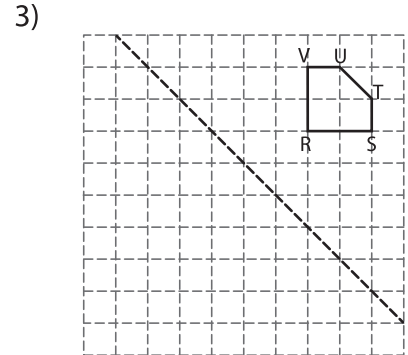
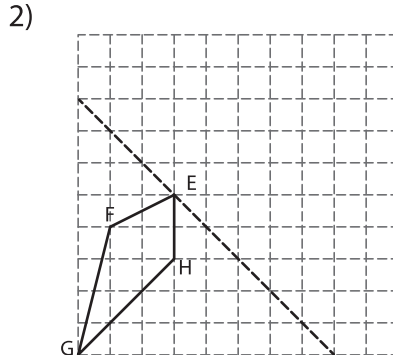
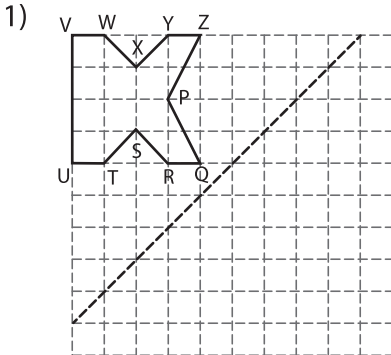

# PREVIEW

Gain complete access to the largest collection of worksheets in all subjects!

Members, please log in to download this worksheet.

Not a member? Please sign up to gain complete access.

[www.mathworksheets4kids.com](http://www.mathworksheets4kids.com)

